

COSMO

HYDRAULIC INDUSTRIES

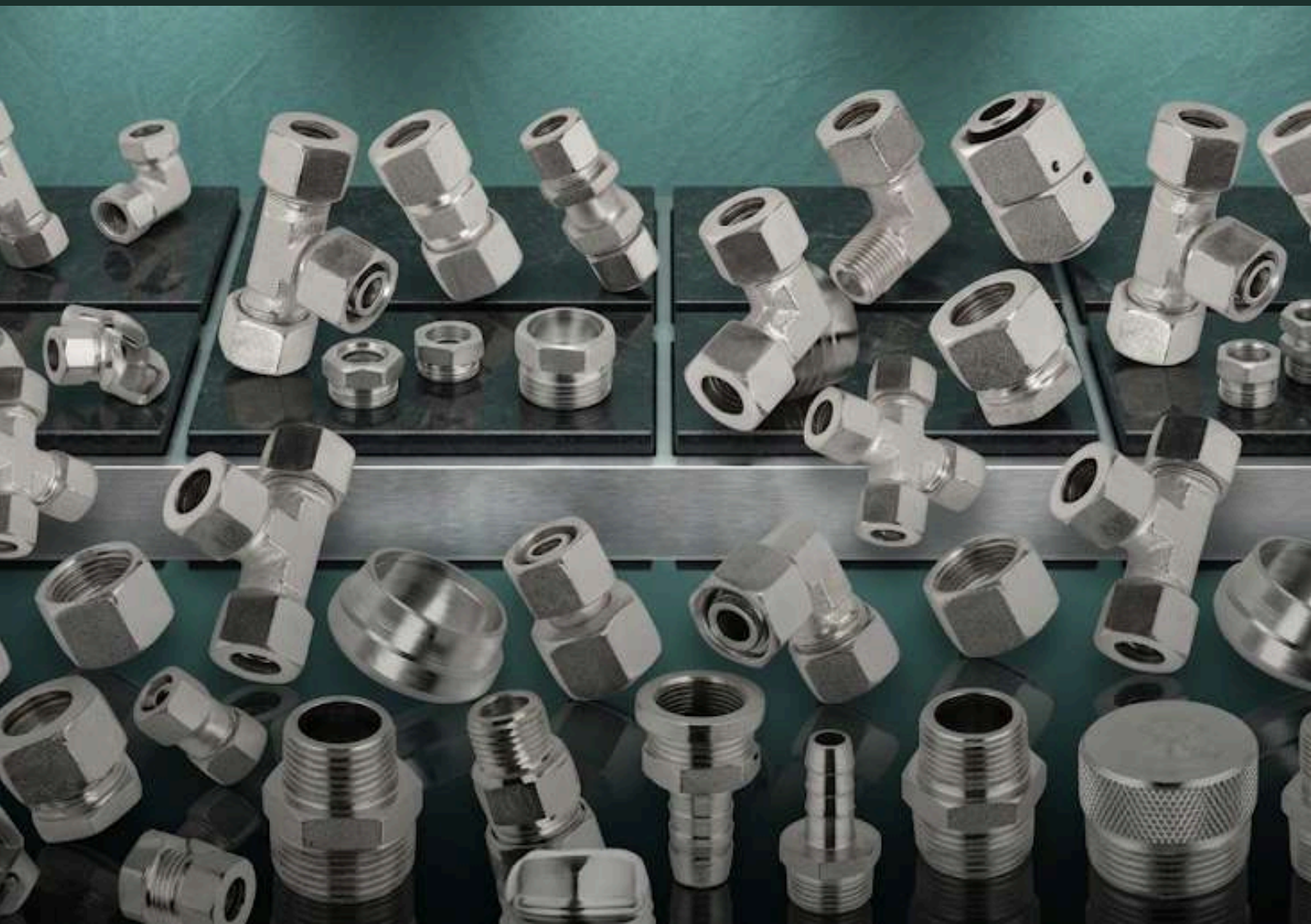

Innovative Hydraulic Solutions for a better Tomorrow
Single Ferrule Fittings



+91 8750048558, +91 8587044434, +91 9870144434



sales@cosmohydraulic.com, cosmo.grnoida@gmail.com



I-149, SITE C, SURAJPUR,
GREATER NOIDA, GB NAGAR, U.P. 201306



SINGLE FERRULE FITTING



ABOUT US

With over 15 years of proven expertise, Cosmo Hydraulic Industries stands as a trusted Indian manufacturer and supplier of high-precision hydraulic and pneumatic fittings and components for mission-critical industrial applications. We are established suppliers to Indian Railways and serve leading sectors including Oil & Gas, Steel, Defence, Infrastructure, and Heavy Engineering. Our products are engineered to deliver consistent performance under extreme pressure and demanding operating conditions. Guided by the Make in India initiative, we emphasize indigenous manufacturing, stringent quality control.

OUR VISION

To represent Make in India on a global platform by delivering world-class hydraulic and pneumatic products with uncompromising quality and precision.

OUR MISSION

- To promote Make in India & Vocal for Local on a global platform.
- To manufacture high-precision hydraulic and pneumatic fittings that meet international standards.
- To continuously improve through technology, process optimization, and skill development.
- To support customers with customized solutions and dependable service.

Specification



Pressure rating as per DIN 2353

Technical Data

Cosmo Hydraulic fitting are available, in Light, Medium and heavy service depending on pipe size. Fittings with weld nipples are available only in heavy series.

LL – Light Series	
100kg/cm ²	Tube OD 4 mm – 8mm

S – Heavy Series	
630kg/cm ²	Tube OD 6 mm–14mm
400kg/cm ²	Tube OD 16mm–25mm
250kg/cm ²	Tube OD 30mm–38mm

L – Medium Series	
250kg/cm ²	Tube OD 6 mm–15mm
160kg/cm ²	Tube OD 18mm–22mm
100kg/cm ²	Tube OD 28mm–42mm

Threading Information

Medium Series (L)										
Tube OD	6mm	8mm	10mm	12mm	15mm	18mm	22mm	28mm	35mm	42mm
BSP/NPT /BSPT METRIC	1/8", M12X1.5	1/4", M14X1.5	3/4", M16X1.5	1/2", M18X1.5	3/4", M22X1.5	1/2", M26X1.5	3/4", M30X2	3/4", M36X2	1", M45X2	1 1/2", M52X2

Heavy Series (S)										
Tube OD	6mm	8mm	10mm	12mm	14mm	16mm	20mm	25mm	30mm	38mm
BSP/NPT /BSPT METRIC	1/4", M14X1.5	3/4", M16X1.5	3/8", M18X1.5	3/8", M20X1.5	3/8", M22X1.5	3/4", M24X1.5	3/4", M30X2	1", M36X2	1", M42X2	1 1/2", M52X2

DIN SINGLE FERRULE FITTING

NUT

BODY



FERRULE

DOUBLE
BITE
TYPE



SINGLE
BITE
TYPE



Single Ferrule

Fitting Body

Nut



Tube

Ferrule bites
the tube to

Our Products

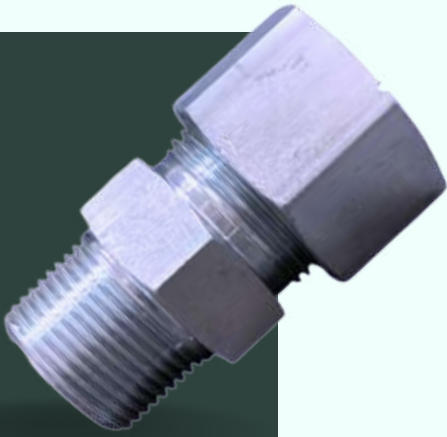

MALE STUD CONNECTOR

Designed for secure threaded connection, this high-performance male stud connector links tubes to ports with strong grip and precision fit. Manufactured with durable material and fine engineering, it ensures tight sealing and reliable operation under pressure. Ideal for hydraulic systems requiring sturdy and leak-resistant connections.

FEMALE STUD CONNECTOR

Designed for secure port connection, this high-quality female stud connector joins tubes with precise threaded engagement. Manufactured with durable material and accurate finishing, it ensures tight sealing and reliable performance under pressure. Ideal for hydraulic systems requiring strong and leak-resistant connections.

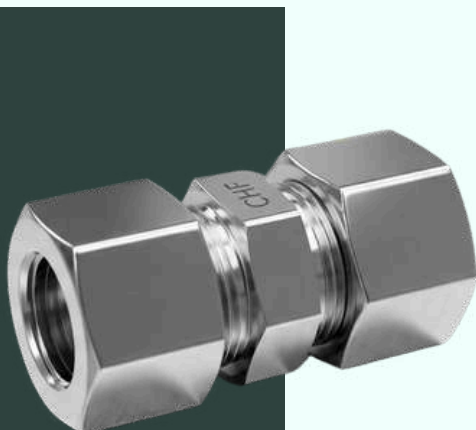

STRAIGHT COUPLING

Straight Coupling
Engineered for seamless connectivity, this high-quality straight coupling ensures a strong, leak-proof joint between tubes or pipes. Designed for durability and precision, it delivers consistent performance even under high pressure conditions. Ideal for hydraulic and industrial applications where reliability matters most.

Our Products



EQUAL ELBOW

Formulated for smooth directional change, this superior equal elbow links two lines at a fixed angle with consistent bore size. Produced with robust material and refined detailing, it supports steady flow and dependable function in demanding conditions. Ideal for hydraulic systems needing uniform alignment and enduring strength.

EQUAL TEE

Built for efficient fluid distribution, this premium equal tee provides a balanced, secure connection across three ends. Crafted with accuracy and robust construction, it maintains smooth flow and dependable operation in demanding systems. Perfect for hydraulic setups requiring uniform branching and long-lasting performance.



EQUAL CROSS

Developed for multi-directional flow distribution, this precision cross fitting connects four lines with uniform efficiency. Manufactured with strong construction and accurate finishing, it delivers smooth transfer and dependable service in high-pressure conditions. Suitable for hydraulic systems requiring balanced flow control and lasting reliability.



Our Products



BULKHEAD UNION

Designed for panel-mounted connection, this high-quality bulkhead union ensures a secure link through walls or partitions. Manufactured with durable material and precise threading, it provides tight sealing and reliable performance under pressure. Ideal for hydraulic systems requiring stable installation and leak-resistant connections.

BULKHEAD ELBOW

Designed for angled panel connection, this high-quality bulkhead elbow provides a secure passage through walls or partitions. Manufactured with durable material and precise construction, it ensures tight sealing and reliable performance under pressure. Ideal for hydraulic systems requiring compact routing and stable installation.

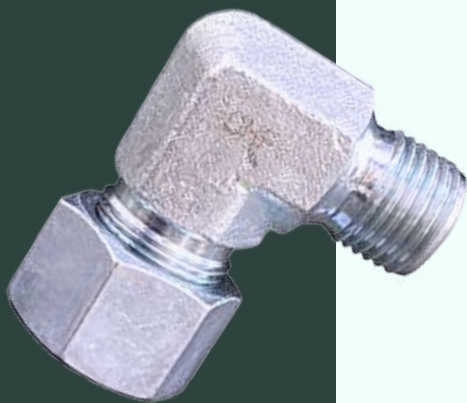

MALE STUD ELBOW

Designed for angled port connection, this high-quality male stud elbow links tubes to threaded ports with precise alignment. Manufactured with durable material and accurate threading, it ensures tight sealing and reliable performance under pressure. Ideal for hydraulic systems requiring compact routing and leak-resistant connections.

Our Products



MALE STUD TEE

Designed for efficient three-way connections, this male stud tee features a male threaded end for secure fitting into ports. Manufactured with durable material and precise threading, it ensures leak-proof performance and reliable operation under pressure. Ideal for hydraulic systems requiring strong and compact connections.

SWIVEL ELBOW

Designed for flexible directional connections, this swivel elbow allows easy alignment during installation. Manufactured with durable material and precision threading, it ensures leak-proof sealing and smooth rotation under pressure. Ideal for hydraulic systems requiring adjustable and secure connections.

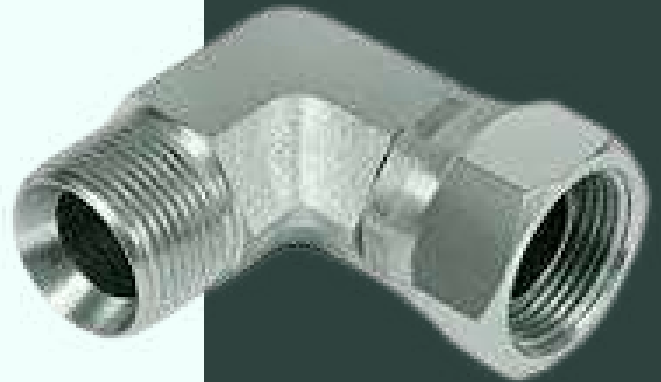

BRANCH TEE

Designed for controlled flow diversion, this high-grade branch tee enables a reliable connection between main and outlet lines. Manufactured with precision and solid strength, it ensures stable performance under varying pressure conditions. Suitable for hydraulic systems requiring efficient branching and consistent durability.



Our Products



STAND PIPE RUN TEE

Designed for vertical flow distribution, this high-quality standpipe run tee ensures a secure connection along the main pipeline with an outlet branch. Manufactured with durable material and precise construction, it provides reliable performance and leak-proof operation under pressure. Ideal for hydraulic systems requiring stable routing and long-lasting durability.

SWIVEL CONNECTOR

Engineered for flexible alignment, this premium swivel connector allows rotational movement for easy installation without twisting the line. Built with precision machining and durable construction, it ensures secure sealing and consistent performance under pressure. Ideal for hydraulic systems requiring adaptability and long-term reliability.

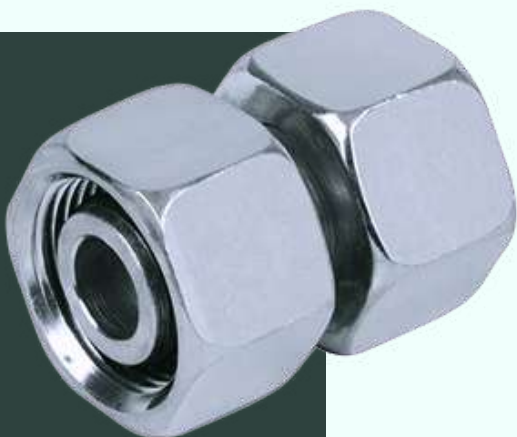

SWIVEL UNION

Designed for flexible joining, this high-quality swivel union allows rotation for easy alignment without stressing the pipeline. Manufactured with durable material and precise construction, it ensures secure sealing and reliable performance under pressure. Ideal for hydraulic systems requiring adjustable installation and long-lasting durability.

Our Products



WELD CONNECTOR BUTT WELD

Engineered for seamless integration, this superior butt weld connector ensures a uniform joint between pipe ends. Fabricated with robust material and precise workmanship, it delivers smooth flow and dependable performance under pressure. Perfect for hydraulic systems requiring strong, leak-free, and permanent connections.

STAND PIPE ADOPTER

Designed for vertical line connection, this high-quality stand pipe adapter ensures a stable and secure link between pipelines. Manufactured with strong construction and precise finishing, it supports consistent flow and reliable performance under pressure. Ideal for hydraulic systems requiring firm installation and long-term durability.

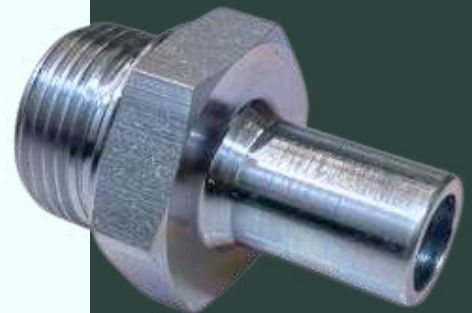

STAND PIPE ADOPTER

Designed for vertical line connection, this high-quality stand pipe adapter ensures a stable and secure link between pipelines. Manufactured with strong construction and precise finishing, it supports consistent flow and reliable performance under pressure. Ideal for hydraulic systems requiring firm installation and long-term durability.

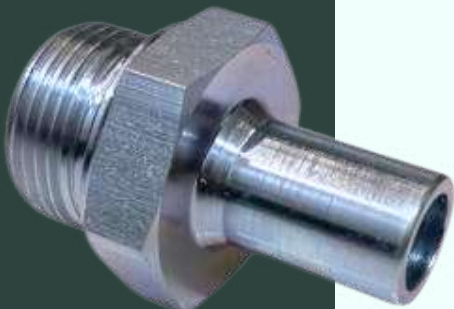

Our Products



SWIVEL CONNECTOR MALE METRIC THREAD

Designed for flexible threaded connection, this high-quality swivel connector allows easy alignment without twisting the line. Manufactured with durable material and precise metric threading, it ensures secure sealing and reliable performance under pressure. Ideal for hydraulic systems requiring adaptability and long-lasting durability.

STAND PIPE ADOPTER

Designed for vertical connection support, this high-quality stand pipe adapter ensures a secure and stable link between pipelines. Manufactured with durable material and precise finishing, it delivers smooth flow and reliable performance under pressure. Ideal for hydraulic systems requiring firm installation and long-term durability.

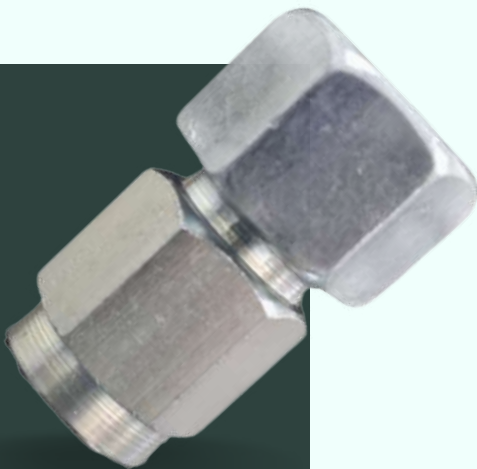

MAV

Designed for secure tube-to-port connection, this high-quality male adaptor ensures precise threaded engagement with a strong hold. Manufactured with durable material and accurate finishing, it delivers tight sealing and reliable performance under pressure. Ideal for hydraulic systems requiring leak-resistant and long-lasting connections.

Our Products



GAUGE ADAPTER BSP TO BSP

Designed for instrument connection, this high-quality gauge adapter ensures secure linking between BSP threaded components. Manufactured with durable material and precise threading, it provides tight sealing and reliable performance under pressure. Ideal for hydraulic systems requiring accurate monitoring and leak-resistant connections.

NUT

Designed for secure fastening, this high-quality nut provides a firm hold for threaded connections. Manufactured with durable material and precise threading, it ensures strong grip and reliable performance under pressure. Ideal for hydraulic systems requiring stable assembly and long-lasting durability.

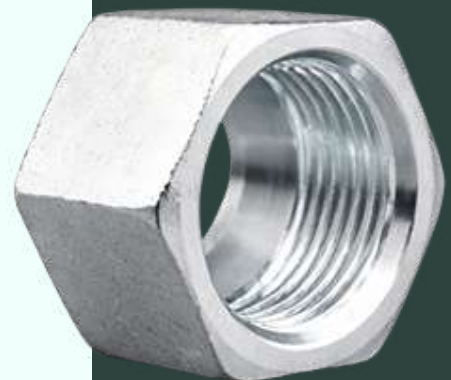

FERRULE

Designed for firm gripping, this high-quality ferrule ensures a tight hold on tubes for secure sealing. Manufactured with durable material and precise shaping, it provides leak-resistant performance under pressure. Ideal for hydraulic systems requiring strong compression and dependable reliability.

Our Products



BSPP-BSP TEE

Designed for parallel thread connections, this high-quality BSPP-BSP tee ensures efficient flow distribution across three points. Manufactured with durable material and precise threading, it provides tight sealing and reliable performance under pressure. Ideal for hydraulic systems requiring consistent flow and leak-resistant connections.

WELD NIPPLE

Designed for permanent joining, this premium weld nipple provides a strong connection between pipe sections. Manufactured with high-grade material and precise finishing, it ensures excellent strength and reliable performance under pressure. Ideal for hydraulic systems requiring durable and long-lasting welded connections.

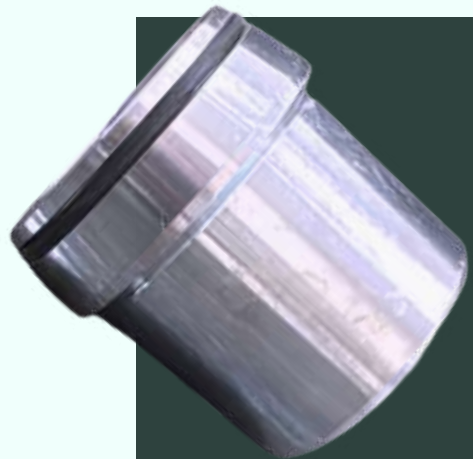

BANJO

Designed for compact fluid transfer, this high-quality banjo fitting enables efficient flow in tight spaces with minimal restriction. Manufactured with durable material and precise construction, it ensures secure sealing and reliable performance under pressure. Ideal for hydraulic systems requiring space-saving design and dependable connections.

Our Products



MINIMESS COUPLING

Designed for pressure testing access, this high-quality Minimesse coupling enables quick and secure connection for diagnostic equipment. Manufactured with durable material and precise construction, it ensures leak-proof performance and reliable operation under pressure. Ideal for hydraulic systems requiring safe monitoring and long-lasting durability.

HEX NIPPLE

Crafted for reliable pipe-to-pipe connections, this high-quality hex nipple is designed with a central hex body for easy installation using a wrench. Manufactured from durable material with precision threading on both ends, it ensures leak-proof performance and strong mechanical strength.



HEX ADAPTER

Designed for connecting different threaded components, this hex adapter features a hex body for easy wrench tightening. Manufactured with durable material and precision threading, it ensures leak-proof sealing and reliable performance under pressure. Ideal for hydraulic systems requiring secure and versatile connections.

Our Products



BSPP-BSPP ELBOW

Designed for parallel thread alignment, this high-quality BSPP-BSPP elbow enables smooth directional change with secure connections. Manufactured with durable material and precise threading, it ensures tight sealing and reliable performance under pressure. Ideal for hydraulic systems requiring efficient flow control and leak-resistant joints.

BSPP-BSPP CROSS

Designed for four-way connections, this BSPP-BSPP cross ensures uniform distribution in hydraulic systems. Manufactured with durable material and precise BSPP threading, it provides leak-proof sealing and reliable performance under pressure. Ideal for applications requiring multiple line connections.

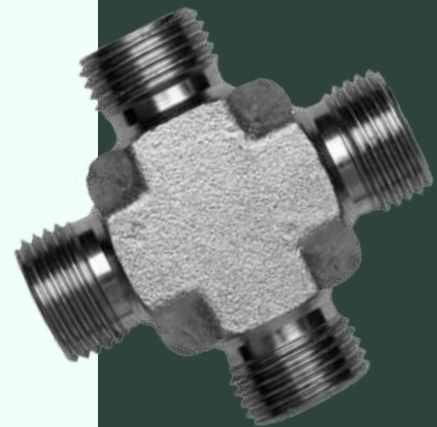

BSPP-BSPP TEE

Designed for parallel thread connections, this high-quality BSPP-BSPP tee ensures efficient flow distribution across three points. Manufactured with durable material and precise threading, it provides tight sealing and reliable performance under pressure. Ideal for hydraulic systems requiring consistent flow and leak-resistant connections.

Our Products

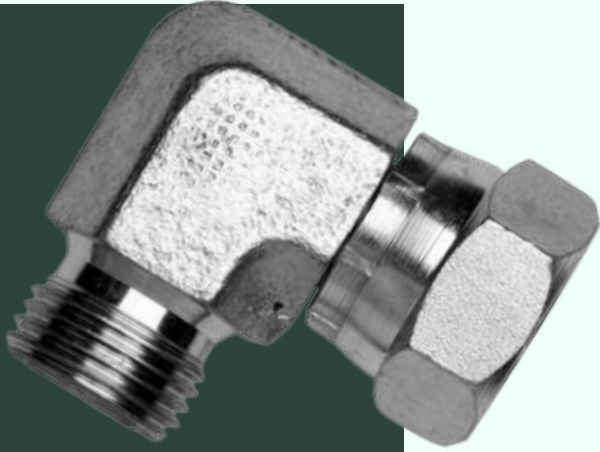

BSPP SWIVEL ELBOW

Designed for flexible directional connections, this BSPP swivel elbow allows easy alignment during installation. Manufactured with durable material and precise BSPP threading, it ensures leak-proof sealing and smooth rotation under pressure. Ideal for hydraulic systems requiring adjustable and secure connections.

BSPP SWIVEL TEE BRANCH

Designed for efficient three-way connections, this BSPP swivel tee branch allows flexible alignment during installation. Manufactured with durable material and precise BSPP threading, it ensures leak-proof sealing and reliable performance under pressure. Ideal for hydraulic systems requiring secure and adjustable branching.



BSPP SWIVEL TEE RUN

Designed for efficient three-way connections, this BSPP swivel tee run allows smooth alignment along the main line during installation. Manufactured with durable material and precise BSPP threading, it ensures leak-proof sealing and reliable performance under pressure. Ideal for hydraulic systems requiring secure and stable flow distribution.

Our Products



BSP NUT NIPPLE

Designed for threaded pipe connection, this high-quality BSP nut nipple ensures a secure link between components with accurate fit. Manufactured with durable material and precise threading, it provides tight sealing and reliable performance under pressure. Ideal for hydraulic systems requiring strong and leak-resistant connections.

HALF BEND

Designed for moderate directional change, this high-quality half bend allows smooth flow transition between connected lines. Manufactured with durable material and precise construction, it ensures reliable performance and secure operation under pressure. Ideal for hydraulic systems requiring controlled routing and long-lasting durability.

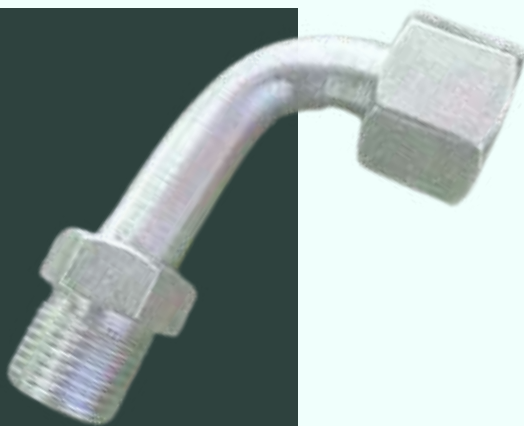

MALE FEMALE BEND

Crafted for angled connectivity, this high-quality male female bend joins threaded ends with a smooth directional shift. Manufactured with solid construction and accurate finishing, it ensures tight sealing and steady performance under pressure. Ideal for hydraulic systems requiring compact routing and dependable strength.

Our Products



COPPER WASHER

Designed for effective sealing, this high-quality copper washer provides a tight barrier between connected surfaces. Manufactured from premium copper with precise finishing, it ensures excellent leak resistance and reliable performance under pressure. Ideal for hydraulic systems requiring durable sealing and long-lasting efficiency.

BONDED SEAL

Designed for enhanced sealing, this high-quality bonded seal combines a metal washer with an elastomer layer for superior leak prevention. Manufactured with durable materials and precise bonding, it ensures reliable performance under pressure. Ideal for hydraulic systems requiring secure sealing and long-lasting durability.

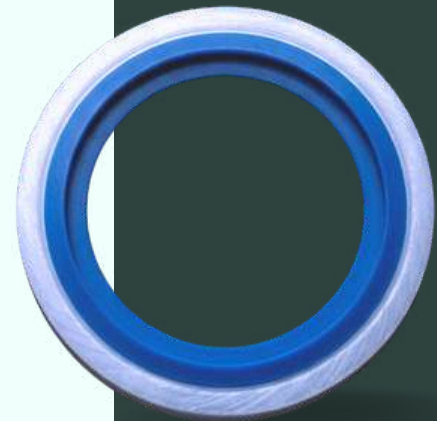

ALLEN PLUG

Designed for internal drive tightening, this high-quality Allen plug ensures a secure closure with a clean finish. Manufactured with strong material and precise threading, it provides leak-proof performance under pressure. Ideal for hydraulic systems requiring compact sealing and dependable protection.

Our Products



DEAD PLUG

Designed for complete closure, this high-quality dead plug securely seals unused ports to prevent leakage and contamination. Manufactured with durable material and precise threading, it ensures reliable performance under pressure. Ideal for hydraulic systems requiring safe sealing and long-lasting durability.

FLOW CONTROL VALVE

Designed for regulating fluid speed, this high-quality flow control valve ensures consistent and controlled output. Manufactured with durable material and precise construction, it provides stable performance and reliable operation under pressure. Ideal for hydraulic systems requiring accurate flow management and long-lasting durability.



NEEDLE VALVE

Designed for fine flow regulation, this high-quality needle valve ensures accurate control with smooth adjustment. Manufactured with durable material and precise construction, it provides tight sealing and reliable performance under pressure. Ideal for hydraulic systems requiring precise control and long-lasting durability.

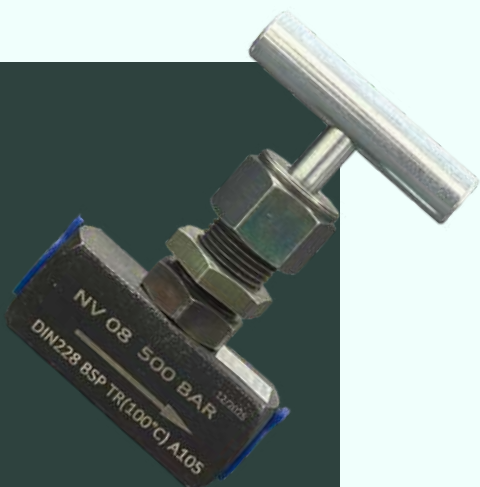

Our Products



DIVERTER VALVE

Designed for directing fluid paths, this high-quality diverter valve allows smooth switching between multiple lines. Manufactured with durable material and precise construction, it ensures reliable performance and consistent operation under pressure. Ideal for hydraulic systems requiring controlled flow direction and long-lasting durability.

CHECK VALVE

Designed for one-way flow control, this high-quality check valve prevents backflow and protects system components. Manufactured with durable material and precise construction, it ensures reliable performance and consistent operation under pressure. Ideal for hydraulic systems requiring safe flow direction and long-lasting durability.

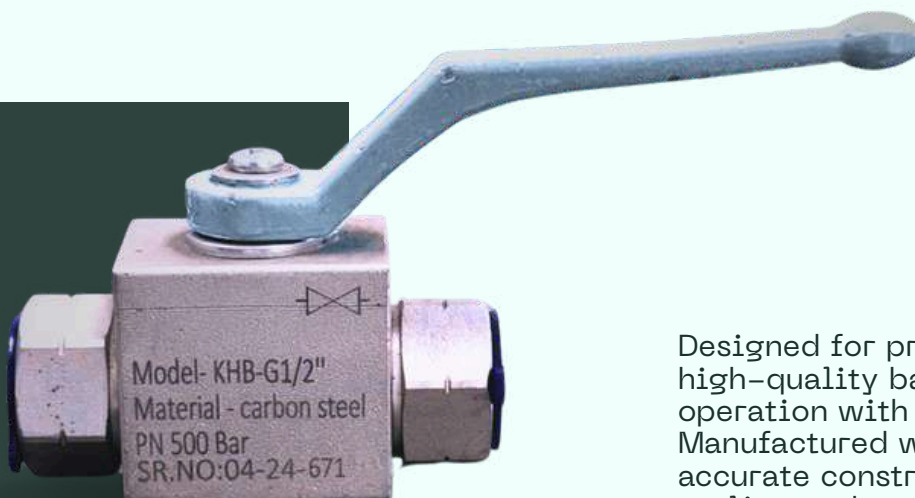
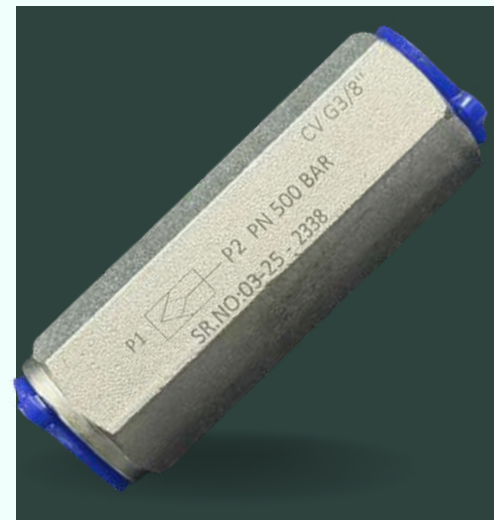

BALL VALVE

Designed for precise flow control, this high-quality ball valve ensures smooth operation with reliable shut-off capability. Manufactured with durable material and accurate construction, it provides tight sealing and consistent performance under pressure. Ideal for hydraulic systems requiring efficient control and long-lasting durability.

Our Products



HYDRAULIC CLAMP

Designed for firm pipe support, this high-quality hydraulic clamp ensures stable holding and vibration control. Manufactured with strong material and precise design, it provides secure grip and reliable performance under pressure. Ideal for hydraulic systems requiring safe installation and long-lasting durability.

QUICK RELEASE COUPLING

Engineered for fast and effortless connection, this advanced QRC enables instant joining and separation without tools. Built with high precision and durable construction, it ensures secure sealing and reliable performance under pressure. Ideal for hydraulic systems requiring quick, safe, and efficient operation.

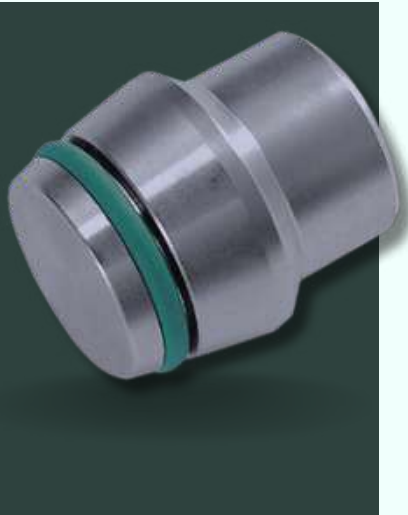

BLANKING PLUG

Designed for secure sealing, this high-quality blanking plug effectively closes unused ports or pipe ends. Manufactured with durable material and precise threading, it ensures leak-proof performance under pressure. Ideal for hydraulic systems requiring safe closure and reliable protection.



COSMO HYDRAULIC INDUSTRIES

MANUFACTURER OF HYDRAULIC FITTINGS



I-149, SITE C, SURAJPUR, GREATER NOIDA, GB NAGAR,
U.P. 201306



sales@cosmohydraulic.com, cosmo.grnoida@gmail.com



+91 8750048558, +91 8587044434, +91 9870144434



www.cosmohydraulic.com

